

DV207
Vibratory Roller

SERVICE MANUAL

Part number 845571 IA

English
April 2012



DV207

Service Manual

Print No. 8455711A



QUICK REFERENCE – CHAPTER GUIDE

SECTION 00 – MAINTENANCE

GENERAL INSTRUCTIONS

1. Introduction
2. Safety precautions
3. Repair safety precautions
4. Product identification
5. Check the tightening of bolted joints

SECTION 00 – MAINTENANCE

GENERAL SPECIFICATIONS

6. Description of the machine
7. Tooling

SECTION 10 – ENGINE

8. Removing the engine
9. Removing the cooler

SECTION 35 – HYDRAULIC SYSTEM

10. Hydraulic system
11. Hydraulics

SECTION 39 – FRAMES

12. Articulated joint
13. Removing the hood

SECTION 41 - STEERING

14. Steering cylinder

SECTION 44 – AXLES AND WHEELS

15. Removing the drum

SECTION 50 – CAB CLIMATE CONTROL

16. Removing the heater/cooling air fans

SECTION 55 – ELECTRICAL SYSTEM

17. Electrical installation
18. Electrical system

SECTION 90 – CAB

19. Cab

INDEX

**Thanks very much for your reading,
Want to get more information,
Please click here, Then get the complete
manual**

JustClickHere 

NOTE:

**If there is no response to click on the link above,
please download the PDF document first, and then
click on it.**

**Have any questions please write to me:
admin@servicemanualperfect.com**

Contents

SECTION 00 – MAINTENANCE

GENERAL INSTRUCTIONS

1. Introduction	1-1
2. Safety precautions	2-1
2.1. Safety section	2-2
2.1.1. Precautionary statements – personal safety signal words.....	2-2
2.1.2. Machine safety and information signal words.....	2-2
2.1.3. General safety rules.....	2-3
2.1.4. General operating safety	2-4
2.2. Safety sign location overview	2-5
2.2.1. Safety signs	2-6
2.3. General maintenance safety.....	2-10
2.3.1. Fire and explosion prevention.....	2-10
2.3.2. Hazardous chemicals	2-11
2.3.3. Battery safety.....	2-11
2.3.4. Air conditioning system	2-12
2.3.5. Transportation safety	2-12
2.3.6. Proper entry and exit	2-12
2.3.7. Operator presence system	2-12
2.3.8. Operator protective structure	2-13
2.3.9. Utility safety	2-13
2.4. Hand signals.....	2-14
3. Repair safety precautions	3-1
3.1. Safety regulations.....	3-2
3.2. Ecological measures & hygiene principles	3-6
3.3. Fire measures.....	3-7
4. Product identification	4-1
4.1. Summary of applications	4-2
5. Check the tightening of bolted joints.....	5-1
5.1. Check the tightening of bolted joints.....	5-2

SECTION 00 – MAINTENANCE

GENERAL SPECIFICATIONS

6. Description of the machine	6-1
6.1. Machine construction.....	6-2
6.2. Fluid/lubricant specifications.....	6-3
6.2.1. Engine oil.....	6-3
6.2.2. Fuel.....	6-4
6.2.3. Coolant	6-5
6.2.4. Hydraulic oil	6-5
6.2.5. Lube grease	6-5
6.2.6. Washer fluid	6-5
6.2.7. Gear oil	6-5
6.3. Technical data DV207.....	6-6
6.4. Dimensional diagram DV207.....	6-8

TABLE OF CONTENTS

7. Tooling	7-1
7.1. Tooling and equipment.....	7-2

SECTION 10 – ENGINE

8. Removing the engine	8-1
9. Removing the cooler	9-1

SECTION 35 – HYDRAULIC SYSTEM

10. Hydraulic system	10-1
10.1. Hydraulic diagram.....	10-3
11. Hydraulics.....	11-1
11.1. Removing the cooling hydromotor	11-4
11.2. Removing the gear pump for steering	11-8
11.3. Removing the tandem pumps for vibration and travel	11-14
11.3.1. Vibration pump.....	11-14
11.3.2. Travel pump	11-16
11.4. Adjusting vibration frequency.....	11-18
11.5. Adjusting pulse sensors.....	11-19
11.6. Measuring hydraulic circuit safety pressures	11-20

SECTION 39 – FRAMES

12. Articulated joint	12-1
12.1. Preparation work.....	12-4
12.2. Removing the steering joint	12-10
12.3. Removing the slewing ring bearing.....	12-15
12.4. Removing the steering joint bearing	12-16
12.5. Installing the steering joint bearing	12-19
12.6. Adjusting the zero position of the steering joint	12-22
13. Removing the hood.....	13-1

SECTION 41 - STEERING

14. Steering cylinder	14-1
14.1. Removing hydraulic cylinders for steering and CRAB	14-4
14.2. Replacing packing material for steering or Crab hydraulic cylinders	14-5

SECTION 44 – AXLES AND WHEELS

15. Removing the drum	15-1
15.1. Removing the vibration hydromotor.....	15-12
15.2. Removing the travel hydromotor.....	15-14
15.3. Removing the auxiliary transmission	15-16
15.4. Removing the front drum	15-18
15.5. Replacing the rubber mounting of the drum	15-30

SECTION 50 – CAB CLIMATE CONTROL

16. Removing the heater/cooling air fans	16-1
16.1. Removing the heater	16-4
16.2. Removing cooling air fans	16-8

SECTION 55 – ELECTRICAL SYSTEM

17. Electrical installation17-1

- 17.1. Fuses 17-2
- 17.2. Storage battery 17-4
- 17.3. Alternator 17-5
- 17.4. Starter motor 17-7
- 17.5. Layout of wiring elements in the machine..... 17-10

18. Electrical system.....18-1

- 18.1. Wiring diagram DV207..... 18-3

SECTION 90 – CAB

19. Cab19-1

- 19.1. Idle and parking brake position sensor 19-4
- 19.2. Left-hand control panel, reversing horn sensor 19-4
- 19.3. Seat platform 19-8
- 19.4. Power steering servo 19-12
- 19.5. Seat switch 19-16

INDEX

TABLE OF CONTENTS

SECTION 00 – MAINTENANCE

GENERAL INSTRUCTIONS

1.Introduction

SECTION 00 – MAINTENANCE – CHAPTER 1

This service manual is divided into several chapters. It includes technical and assembly data, adjustment guidelines and instructions in the use of special tools, jigs and aids.

The primary purpose of this Service Manual is to provide basic information on removal, installation and servicing/repair of the machine's main groups.

Machine group identification in this manual corresponds to the Spare Parts Catalog.

Before beginning work, we recommend that you mark any removed parts that will be reinstalled and that you cover all holes in individual hydraulic system parts to prevent hydraulic circuit contamination.

When installing individual parts in the machine, tighten individual bolts or nuts as indicated in the torque tables (appendix) unless otherwise indicated in the text.

ALWAYS observe the safety instructions and precautions indicated in Chapter 2.

The manufacturer is continually improving the products based on operational experience and the latest knowledge. Consequently, the manufacturer reserves the right to make changes to the illustrations, descriptions, procedures or design patterns given in this manual as developments are made.

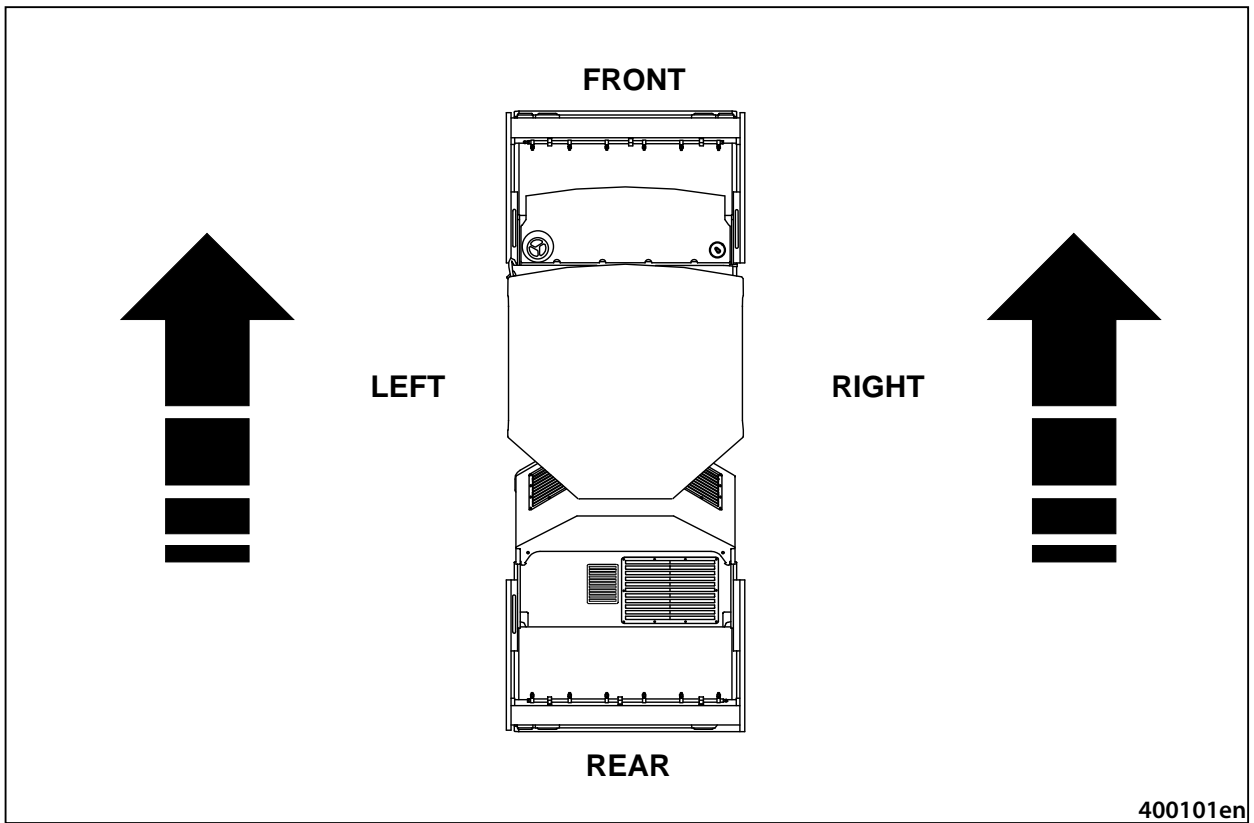

400101en

SECTION 00 – MAINTENANCE – CHAPTER 1

Notes

SECTION 00 – MAINTENANCE

2.Safety precautions

2.1. Safety section

Your safety and that of people around you depends on you. It is essential that you understand this manual to ensure the correct operation, inspection and maintenance of this machine.

Read this manual carefully and check that you fully understand:

- The symbols on the controls and the safety signs used in this manual and on the machine.
- The speed, stability, braking and steering characteristics of the machine. If you are in any doubt, consult your dealer.

The safety messages in this manual concern situations which may arise during normal machine operation and servicing. These safety messages also indicate the various ways of coping with these situations.

2.1.1. Precautionary statements – personal safety signal words



This is the safety alert symbol. It is used to alert you to potential personal injury hazards. Obey all safety messages that follow this symbol to avoid possible injury or death.

Throughout this manual and on the machine safety signs, you will find the signal words **DANGER**, **WARNING** and **CAUTION** followed by specific instructions. These precautions are intended for the personal safety of you and those working with you. Please take the time to read them.



DANGER



DANGER indicates a hazardous situation which, if not avoided, will result in death or serious injury. The color associated with **DANGER** is RED.



WARNING



WARNING indicates a hazardous situation which, if not avoided, could result in death or serious injury. The color associated with **WARNING** is ORANGE.



CAUTION



CAUTION, used with the safety alert symbol, indicates a hazardous situation which, if not avoided, could result in minor or moderate injury. The color associated with **CAUTION** is YELLOW.

FAILURE TO FOLLOW DANGER, WARNING AND CAUTION INSTRUCTIONS COULD RESULT IN DEATH OR SERIOUS INJURY.

2.1.2. Machine safety and information signal words

NOTICE: NOTICE indicates a situation that could result in machine or property damage if not avoided. The color associated with NOTICE is BLUE.

Throughout this manual, you will find the signal word NOTICE followed by special instructions to prevent machine or property damage. The word NOTICE is used to address practices not related to personal safety.

NOTE: NOTE indicates additional information that clarifies steps, procedures or other information in this manual.

Throughout this manual, you will find the word NOTE followed by additional information about a step, procedure or other information in the manual. The word NOTE is not intended to address personal safety or property damage.

2.1.3. General safety rules

- Never operate the machine under the influence of alcohol, drugs or while otherwise impaired.
- Never permit anyone other than the machine operator to ride on the machine.
- A person or pet within the operating area of a machine can be struck or crushed by the machine or its equipment. DO NOT allow anyone to enter the work area.
- Any person who operates the machine or performs machine maintenance or repairs must be familiar with the guidelines given in this Operator's Manual.
- Keep clear of moving parts. Loose clothing, jewelry, watches, long hair and other loose or hanging items can become entangled in moving parts.
- Always use personal protective equipment (PPE), such as work clothing, safety boots, hard hat and hearing protection.
- Make sure all guards and shields are in good condition and properly installed before operating the machine. Never operate the machine with the shields or guards removed.
- Make sure all components are in good condition and tighten all connections before starting the engine or pressurizing the system.
- Dirty or slippery steps, ladders, handholds, walkways and platforms can cause falls. Make sure these surfaces remain clean and clear of debris.
- Operate machine controls only when seated in the operator seat.
- Before starting the machine, be sure that the drive controls are in their neutral position.
- DO NOT attempt to remove material from any part of the machine while it is being operated or components are in motion.
- Never smoke or handle open flames when checking or pumping fuels, refilling oils, lubricating the machine or inspecting or pressurizing the accumulator.
- Seat belt inspection and maintenance:
 - a. Keep seat belts in good condition.
 - b. Keep the belts away from sharp edges and items that could cause damage.
 - c. Periodically check belts, buckles, retractors, tethers, slack take-up system and mounting bolts for damage.
 - d. Replace all parts that have damage or wear.
 - e. Replace belts that have cuts that can make the belt weak.
 - f. Check that bolts on the seat bracket or mounting are tight.
 - g. If the belt is attached to the seat, make sure the seat or seat brackets are mounted securely.
 - h. Keep seat belts clean and dry.
 - i. Clean belts with soap solution and warm water only.
 - j. Do not use bleach or dye on the belts because this can make the belts weak.

CALIFORNIA**PROPOSITION 65 WARNING**

Diesel engine exhaust and some of its constituents are known to the State of California to cause cancer, birth defects and other reproductive harm.

Battery posts, terminals and related accessories contain lead and lead compounds. Wash your hands after handling.

SECTION 00 – MAINTENANCE – CHAPTER 2

2.1.4. General operating safety

Before starting work, the operator must do the following:

- Be familiar with the work site environment, i.e. with the slopes, utility line system, as well as with necessary types of work site protections.
- Indicate each machine start-up with an acoustic or light signal and allow a few moments for personnel to leave the work area before turning on the machine engine.
- Confirm brake and steering functionality before operating the machine.
- Always make sure the work area is clear of tools, parts, other persons and pets before you start operating the machine.
- Always keep windows, mirrors, all lighting and the Slow Moving Vehicle (SMV) emblem clean to provide the best possible visibility while operating the machine.
- Never operate the machine in enclosed spaces as harmful exhaust gases may build up.
- DO NOT operate the machine during an electrical storm.
 - If lightning should strike during operation, remain in the cab. Do not leave the cab or operator's platform. Do not make contact with the ground or objects outside the machine.
 - If you are on the ground during an electrical storm, stay away from machinery and equipment. Seek shelter in a permanent, protected structure.
- Before leaving the machine:
 - a. Park the machine on a firm, level surface.
 - b. Put the drive controls in their neutral position.
 - c. Turn off the engine and remove the key.
- Start the engine from the operator seat only.
- DO NOT roll and compact at slopes of such angles where there is a risk of soil breaking off (dropping) under the machine or a risk of loss of grip followed by uncontrolled slip.
- Depending on the bearing capacity of the subsoil, DO NOT roll and compact at such a distance from the edge of the slope or trench that there is a risk of landslide or the shoulder breaking off (dropping) together with the machine.
- DO NOT roll and compact with vibration at such a distance from walls, cuts or slopes that would cause them to slip (slide) and cover the machine.
- DO NOT compact with vibration at such a distance from buildings or facilities and equipment that there is a risk of them being damaged due to vibration transfer impact.
- DO NOT operate the machine when within hazardous reach of other machines or transportation means aside from those that operate in mutual concert with the machine.
- DO NOT operate the machine at places impossible to see from the operator platform and where hazard to people or property could occur unless work safety has been secured through some other way, such as via signaling by duly instructed personnel.
- DO NOT operate the machine under reduced visibility or at night, unless the machine's work area and the work site are illuminated sufficiently.
- Pay attention to overhead power lines and hanging obstacles. High voltage lines may require significant clearance for safety. If the machine comes into contact with high voltage, observe the following principles:
 - do not attempt to leave the operator platform while in the hazardous zone
 - warn others to keep off and not touch the machine
 - try to drive the machine out of the hazardous zone
- When parking the machine on a road, always take into consideration the effect the weight of the machine will have on the road.
- Exposure to loud noises could cause hearing damage. Always wear hearing protection when operating noisy equipment or when working in a noisy environment.

2.2. Safety sign location overview

The following safety signs have been placed on your machine in the areas indicated. They are intended for the personal safety of you and those working with you. Please take this manual and walk around your machine to note the content and location of these safety signs. Review these safety signs and the operating instructions detailed in this manual with your machine operators. Keep the safety signs legible. If they are not, obtain replacements from an authorized dealer. The safety sign replacement part numbers are listed with each safety sign.

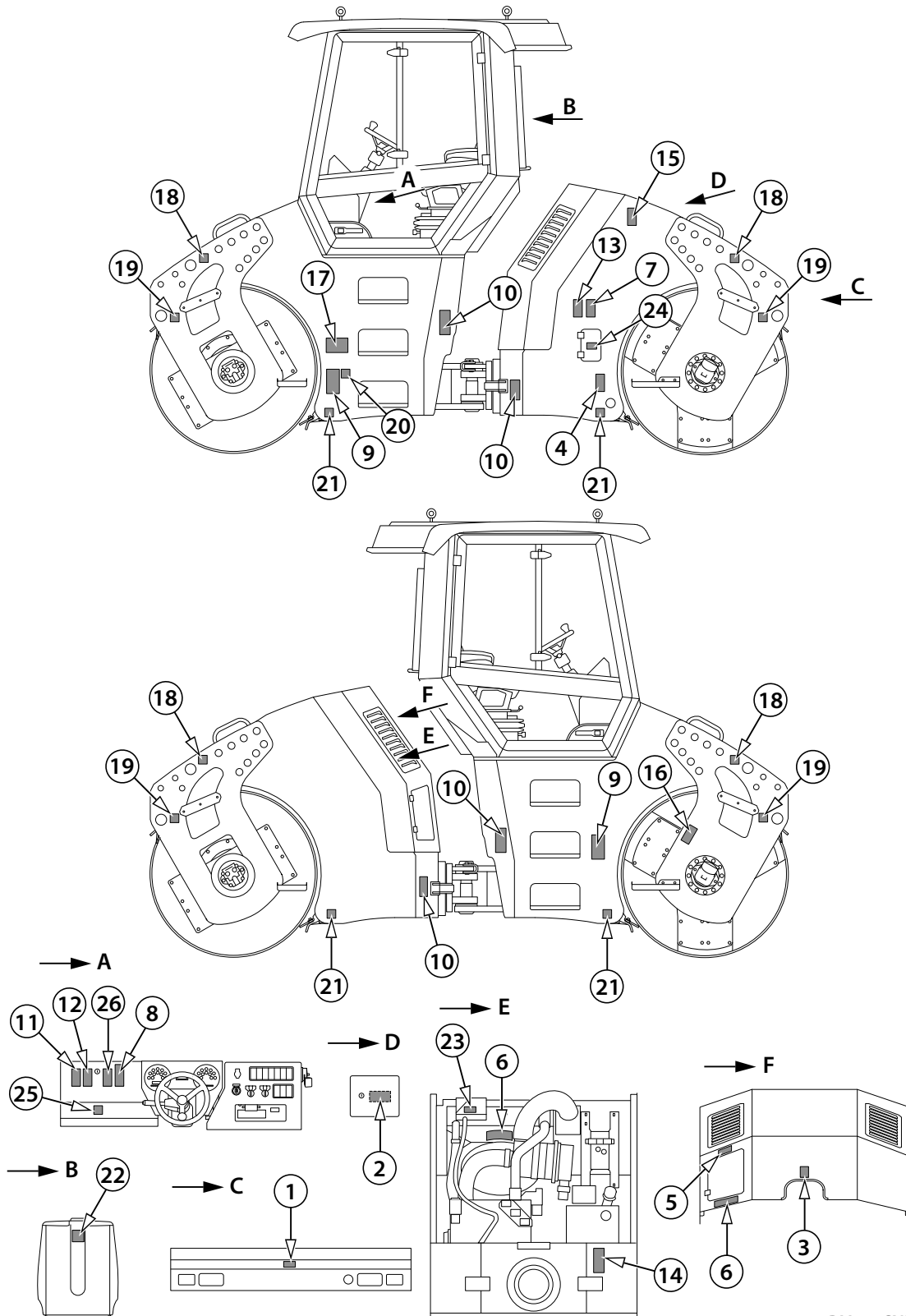

DV207CNH

SECTION 00 – MAINTENANCE – CHAPTER 2

2.2.1. Safety signs

NOTICE

Clean the safety signs and keep them legible – do not use solvent, gasoline or other harsh chemicals to clean the safety signs.

Replace all worn, damaged or missing safety signs.

If a safety sign is on a part that is replaced, make sure the new part has the safety sign.

1. Runover hazard!



Maintain a safe distance from the machine. Failure to comply will result in death or serious injury. (Symbol located at the back)

Part no.: ND148560

Quantity: 1

2. Explosion hazard!



Read the procedure in the Operator's Manual before jump starting or servicing to avoid injury. Failure to comply will result in death or serious injury. (Symbol located on the inner side of the battery door at the rear of the machine)

Part no.: ND106581

Quantity: 1

3. Starting in gear can cause death!

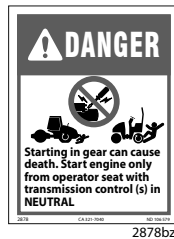

Starting in gear could cause death. Start the engine from the operator seat only with the transmission control(s) in neutral. Failure to comply will result in death or serious injury. (Symbol located on the hood)

Part no.: ND106579

Quantity: 1

4. Hot surface hazard!



Maintain a safe distance from the hot part of the machine. Failure to comply could result in death or serious injury. (Symbol located above the exhaust)

Part no.: ND106591

Quantity: 1

5. Hot liquid under pressure hazard!



Do NOT open the expansion tank cap until the liquid cools down below 50°C (122°F). Failure to comply could result in death or serious injury. (Symbol located on the righthand side of the hood above the door)

Part no.: ND146955

Quantity: 1

6. Entanglement hazard!



Maintain a safe distance from the rotating cooling fan, pulley and belt. Keep clear or stop engine before servicing. Failure to comply could result in death or serious injury. (Symbol located on the right side of the hood and on the cooler)

Part no.: ND109916

Quantity: 2

7. Adjust when stationary!

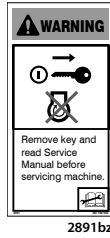

2891bz

Do NOT perform any adjustments or maintenance while the engine is running. Stop the engine, remove the ignition key and read the Service Manual before servicing the machine. Failure to comply could result in death or serious injury. (Symbol located on the left-hand side)

Part no.: ND106592

Quantity: 1

8. Welding hazard!



2892bz

Read Operator's Manual before welding on the machine. Disconnect the alternator before welding on the machine. Failure to comply could result in death or serious injury. (Symbol located on the dashboard)

Part no.: ND106593

Quantity: 1

9. Danger area

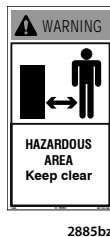

2885bz

Maintain a safe distance from the machine. Failure to comply could result in death or serious injury. (Symbols located on both sides of the machine)

Part no.: ND106586

Quantity: 2

10. Clamping hazard



2887bz

Maintain a safe distance from the machine. Risk of being clamped between the front and rear frame of the machine. Failure to comply could result in death or serious injury. (Symbols located on the left and right near steering joint)

Part no.: ND106588

Quantity: 4

11. Read Operator's Manual!

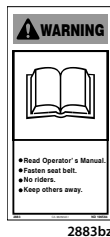

2883bz

Before starting the machine, thoroughly read the safety measures and instructions for controlling the machine and its actuators in the manuals supplied with the machine. Fasten the seat belt. Do not carry passengers or riders. Keep others away. Failure to comply could result in death or serious injury. (Symbol located on the dashboard)

Part no.: ND106584

Quantity: 1

12. Crush hazard!

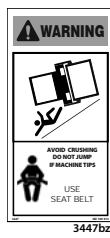

3447bz

Avoid crushing. Do not jump if machine tips. Use the seat belt. Failure to comply could result in death or serious injury. (Symbol located on the dashboard)

Part no.: ND148014

Quantity: 1

SECTION 00 – MAINTENANCE – CHAPTER 2

13. Crush hazard!



3431bz

Engage the hood lock before servicing the machine. Failure to comply could result in death or serious injury. (Symbol located on the left hand side)

Part No.: ND147576

Quantity: 1

14. Crush hazard!



3570bz

Secure the steering joint (lock link) when loading and transporting the machine on a vehicle. Failure to comply could result in death or serious injury. (Symbol located to the left on the rear frame near the joint)

Part No.: 84595622

Quantity: 1

15. Hood locking



3326bz

Lock the hood. (Symbol located on the left side of the machine)

Part no.: ND140504

Quantity: 1

16. Crush hazard!



3433bz

Make sure that no one is within the danger area surrounding the edge cutter. Failure to comply could result in death or serious injury. (Symbol located on right-hand side of the machine (option))

Part No.: ND147578

Quantity: 1

17. Lifting diagram

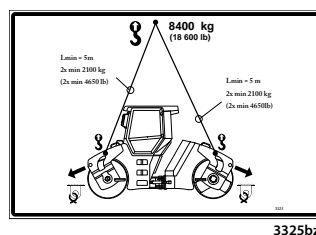

3325bz

Use rigging of sufficient loading capacity to lift the Machine. Secure the Machine's joint before lifting. (Symbol located on the left side of the machine)

Part no.: ND140503

Quantity: 1

18. Lifting lugs



2153bz

Lift the machine using these lugs. (Symbol located on both sides of the machine)

Part no.: ND081460

Quantity: 4

19. Sling points



3048bz

The machine is to be rigged in these points. (Symbols located on both sides of the machine)

Part no.: ND119495

Quantity: 4